

DETAIL A - LINE POST CONNECTION

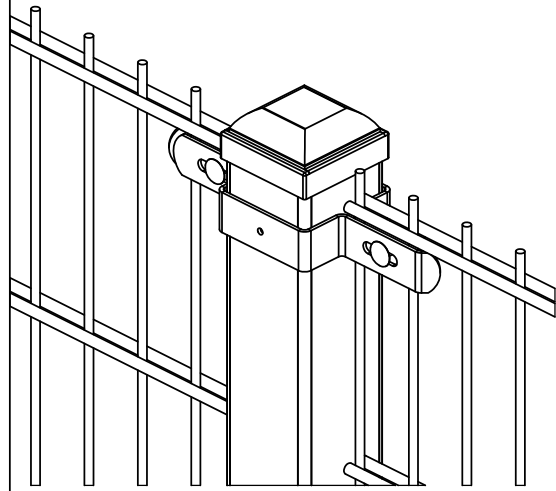

DETAIL D - PANEL CONNECTION DETAIL

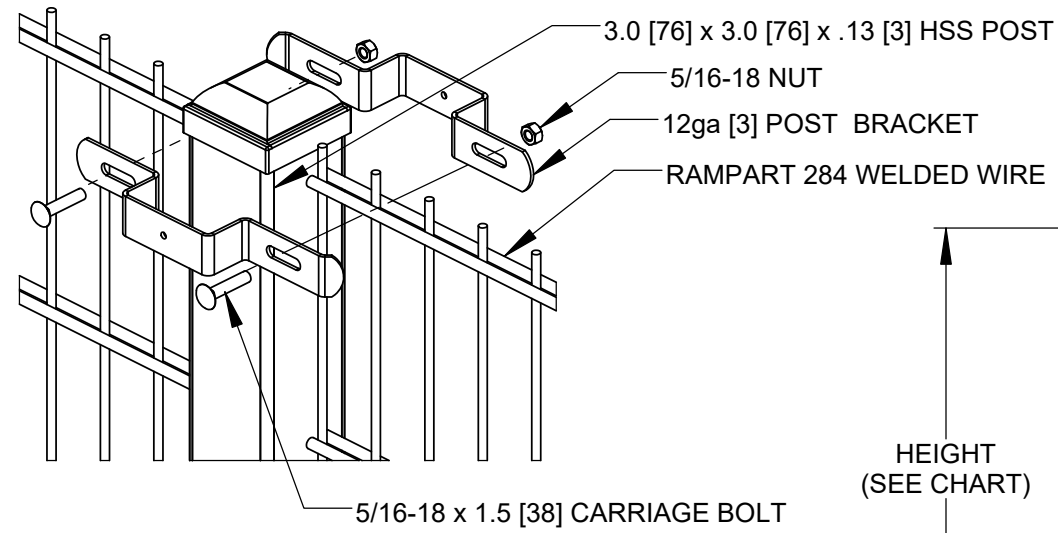

DETAIL B - CORNER POST CONNECTION

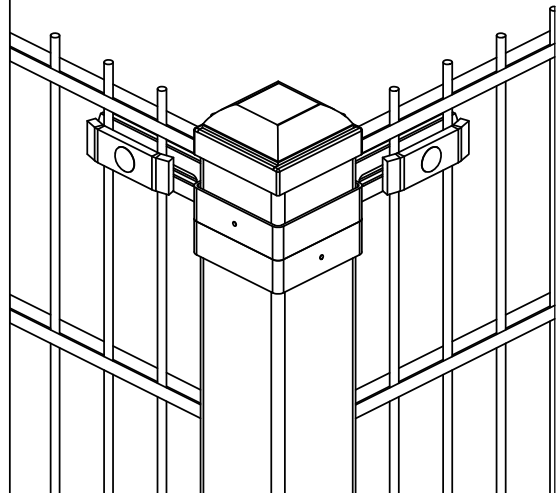

HEIGHT	BRACKET QTY.
4' [1.2]	3
6' [1.8]	4
8' [2.4]	5

DETAIL E - OPTIONAL FLANGE POST

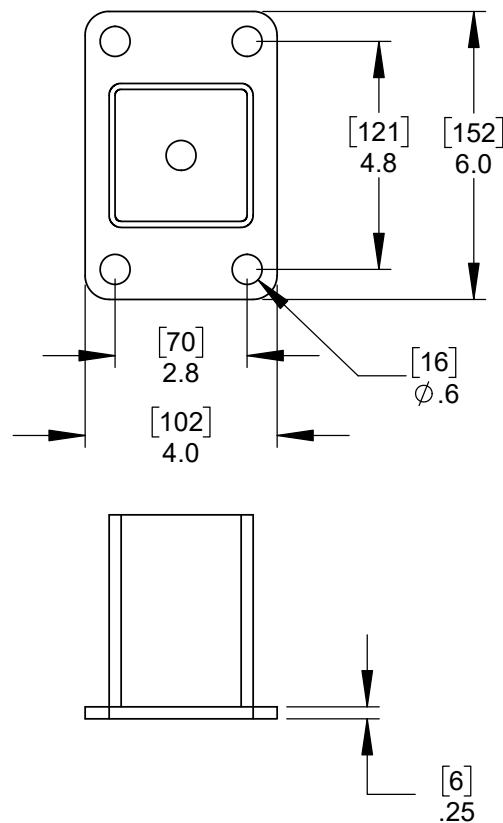

RAMPART 284

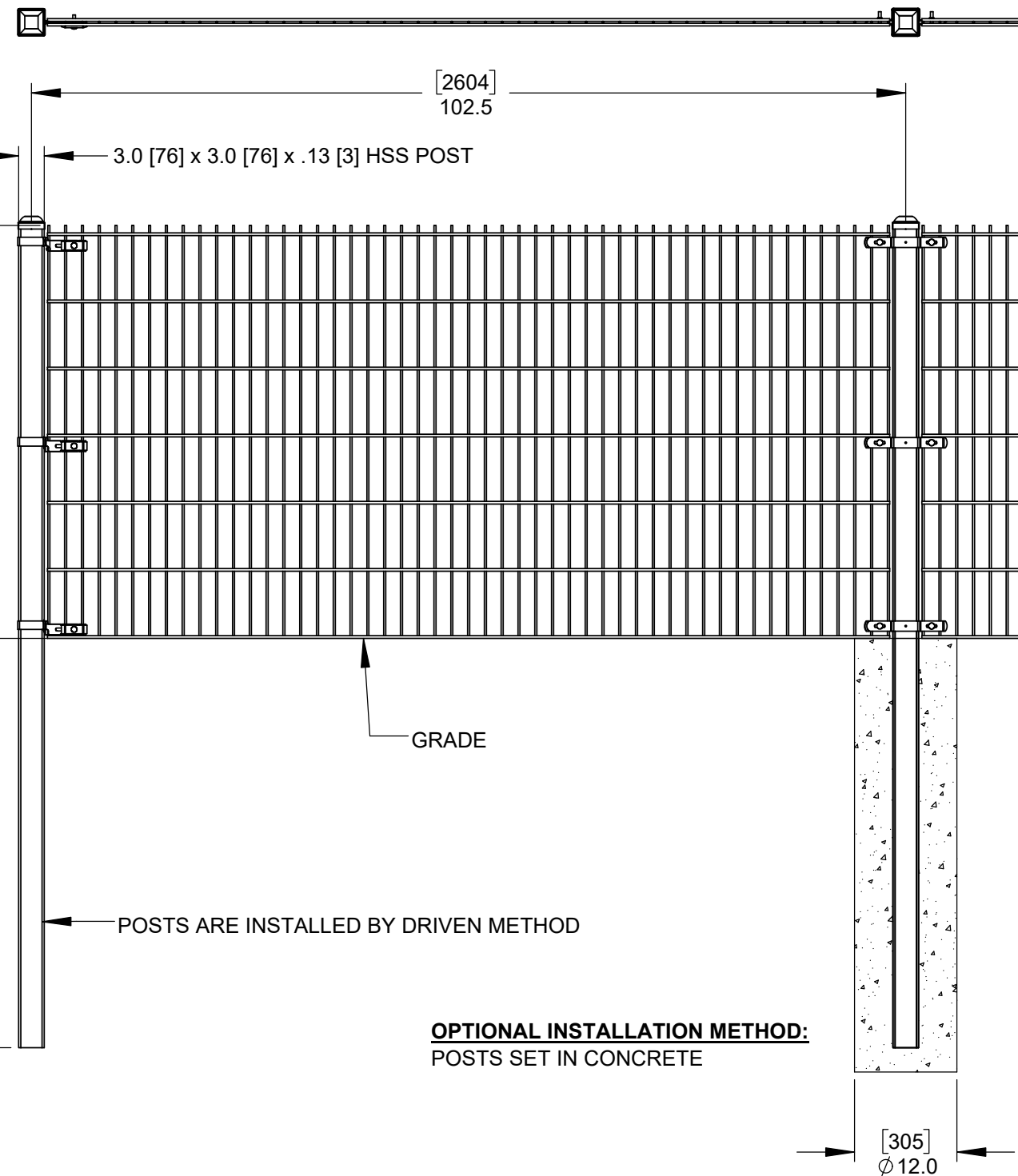
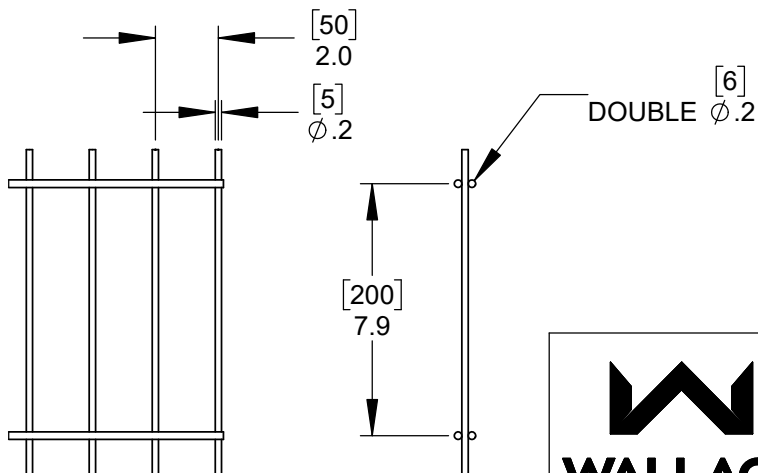

OPTIONAL INSTALLATION METHOD:
POSTS SET IN CONCRETE

DETAIL C - END POST CONNECTION

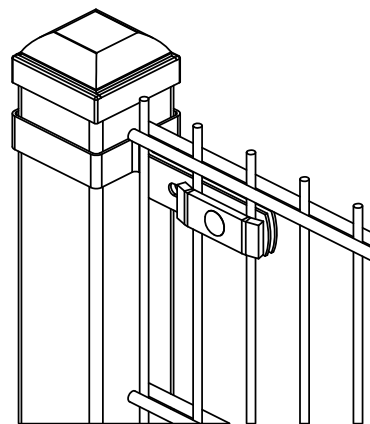

DIMENSIONS ARE INCHES, DIMENSIONS SHOWN IN [] ARE IN MILLIMETERS



115 Lowson Crescent
Winnipeg, Manitoba, Canada, R3P 1A6
Phone: 1-866-300-1110
Fax: 1-204-284-1868
Web: www.wallaceperimetersecurity.com

Description: RAMPART 284 WELDED WIRE FENCE 3.0 [76] x 3.0 [76] SQUARE POSTS		
Customer / Project Name:		
Finish: STANDARD: GALVANIZED OPTIONAL: POWDER COAT, BLACK	Date: 10/7/2020	
Drawing No. RAMPART 284S3	Rev.	Sheet: 1 of 1